

ALM 12V7 Lithium ion Module

A123 Systems lithium ion rechargeable ALM 12V7 battery is based on proven ANR26650 cells. The battery offers high power, long cycle and calendar life, and superior safety due to the use of patented Nanophosphate® technology. ALM 12V7 modules are drop-in replacements for 12V7 lead acid batteries with an integrated on-board cell balancing system that provides long battery life

Key Features and Benefits

- Direct replacement for 12V7 VRLA batteries (same size/charger)
- Power: delivers twice the power at high C-rate while maintaining high energy capacity
- Safety: Superior abuse tolerance compared to lead acid and other lithium ion batteries. In addition to stable chemistry, the battery is continually monitored by internal electronics
- Life: Superior float/cycle/calendar life, even at elevated temperatures and high current (C-rate) discharges. At least 10-20 times longer cycle life than lead acid
- Longer shelf, storage life –Lower self discharge. At least 2 to 5 times longer than lead acid
- Weight: one third the weight of typical lead acid batteries
- Smaller and Lighter Systems –Higher Power and Energy density
- Maintenance free: No testing, monitoring or maintenance required
- Limited environmental impact: Lead free and no hazardous material content

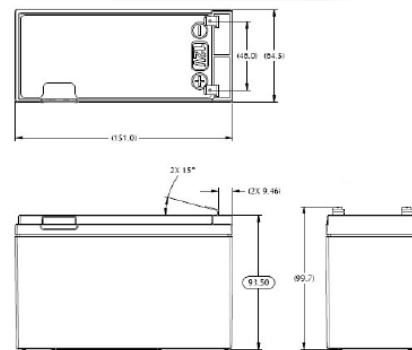

Electrical Specifications			
Nominal Voltage	13.2 V	Charging Continuous Current	10 A max
Nominal Capacity	4.6 Ah	Recharge Voltage Limit	13.8 V min 14.4 V max
Available Energy (BOL)	60 Wh	Recommended Float Voltage	13.8 V
Maximum Output Power followed by a rest period of 2 hours	345 W	Fuse	30 A
Maximum Current Output	30 A (600 s max)	Overvoltage protection	Any Cell above 4 V
Maximum Current Output pulse	54 A (200 ms max) 180 A (10 ms max) at 25 °C	Undervoltage protection	Any cell below 2 V
Cell Configuration	4S2P	Over temperature protection	110 °C
Operating Temperature	-20 °C to +58 °C	Storage Temperature	-40 °C to +60 °C

Mechanical Specifications	
Length	5.95 in/151.0 mm
Width	2.54 in/64.5 mm
Height (including terminals)	3.93 in/99.7 mm
Weight	1.85 lb/0.84 kg
Terminal	0.25 in Faston
Case Material	ABS

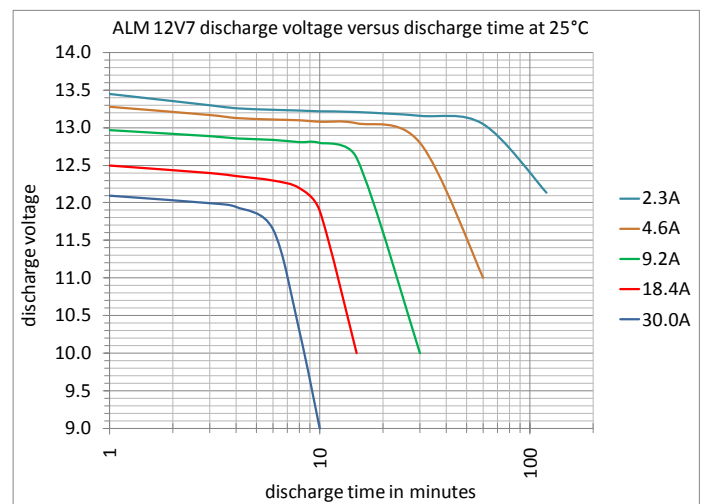

MD100106

Specifications, performance may vary depending on use conditions and application. A123 Systems makes no warranty explicit or implied with this datasheet. Contents subject to change without notice

Copyright A123 Systems
© 2011 All rights reserved

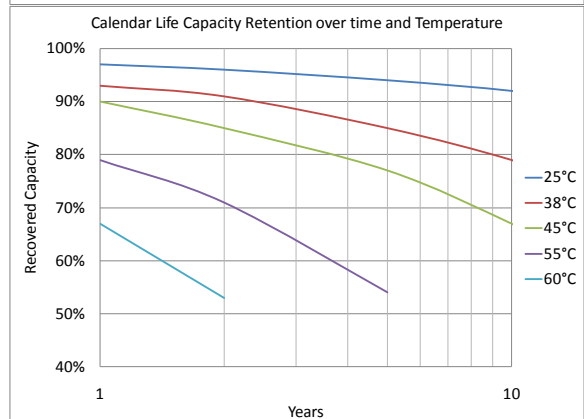
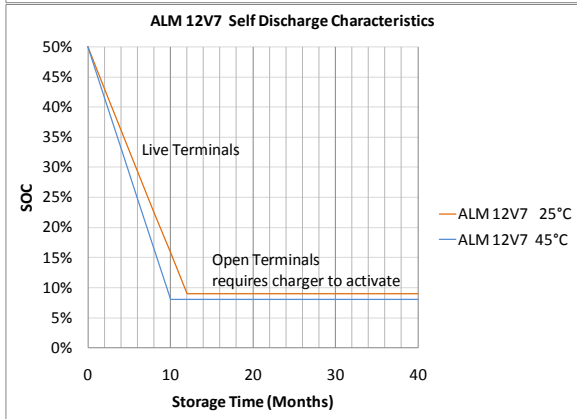
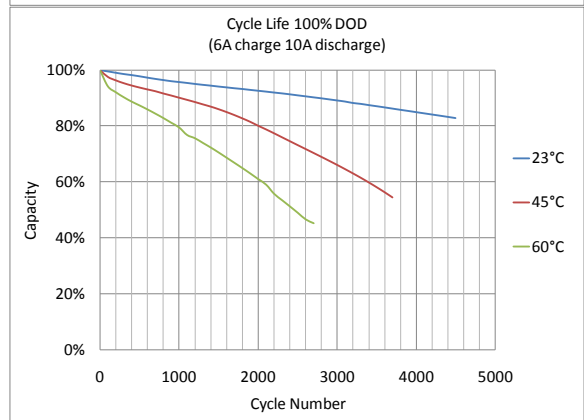
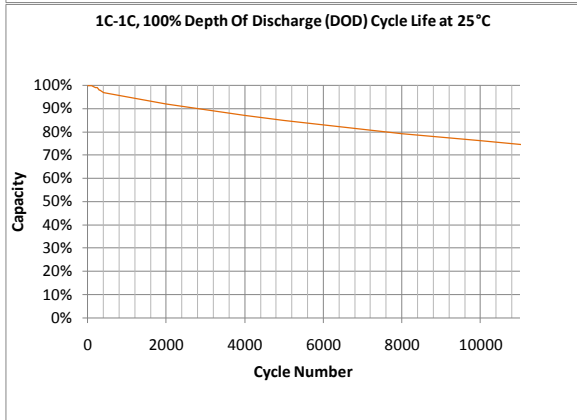
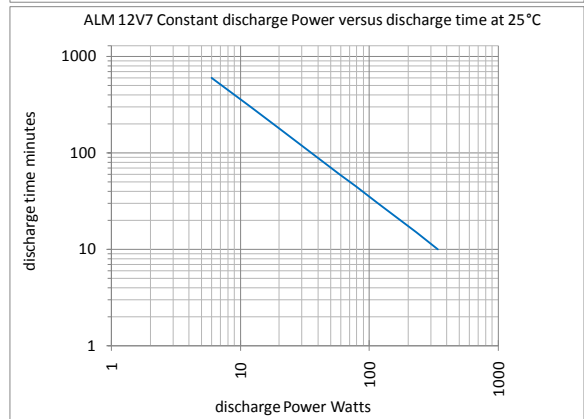
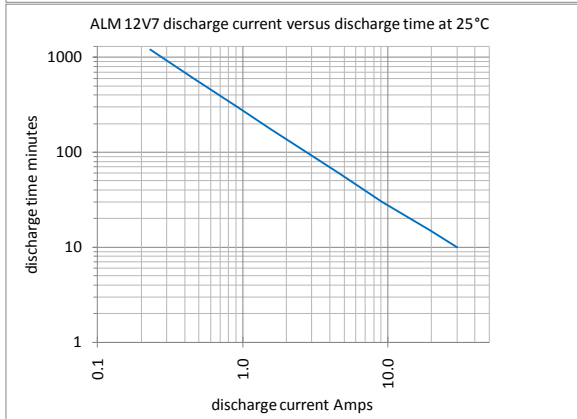
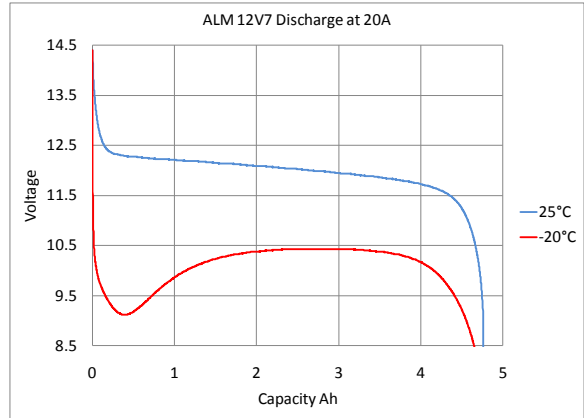
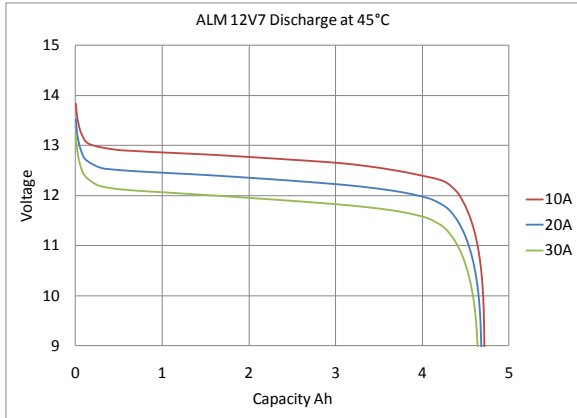

MD100106

Specifications, performance may vary depending on use conditions and application.
 A123 Systems makes no warranty explicit or implied with this datasheet.
 Contents subject to change without notice

Copyright A123 Systems
 © 2011 All rights reserved